

7. 电器/Electric Device

序号/ No.	名 称 / Designation	页 码 /Page No.
7.01	主副油箱转换开关/Main and Auxiliary Fuel Tank Change-over Switch	1
7.02	ABS (4S 4M) 控制装置/ABS ECU	2
7.03	HOWO中央电气控制系统 (NanoBCU) /Central electric control system	3
7.04	HOWO-TFT屏组合仪表 (燃油) /Combination instrument	5
7.05	HW7E组合开关/Combined switch	6
7.06	HW7E载货车电器装置 (ST双桥) /Electric Equipment	7
7.07	HOWO国2/EGR 电气接线盒铭牌 (NanoBCU) 英文/Nameplate	8
7.08	挂车七孔插座--24N型/Trailer seven hole socket (24N)	9
7.09	ABS (4S/4M) 底盘电器 (WABCO) /Chassis Electric Device	10
7.10	145-320马力4*2/4*4底盘电器/Chassis Electric Device	11
7.11	240-320马力底盘电器/Chassis Electric Device	12
7.12	底盘电器/Chassis Electric Device	13
7.13	HOWO车前照灯/Headlamp	14
7.14	蓄电池 (165安-时) /165 AH Battery	15
7.15	新型电瓶箱/Battery Box	16
7.16	断开式悬架ABS电线 (6X4, 4300) /ABS electric wire	18
7.17	尾灯电线/Rear Lamp Wireness	19
7.18	车架电线束 (1050) /Wiring harness	20

7.19	ABS驾驶室电线束 (WABCO) /ABS Cab wireness		21
7.20	国2车型起动机附加电线束/Starter wiring harness		22
7.21	起动机电线束/Starter Wireness		23
7.22	HW7E载货车底盘电线(全挂车)/Chassis Wireness		24
7.23	HW7E驾驶室电线束/Cab wiring harness		25
7.24	轮、轴间差速锁电线/Diff. Lock Wireness		27

7.02 ABS (4S 4M) 控制装置/ABS ECU

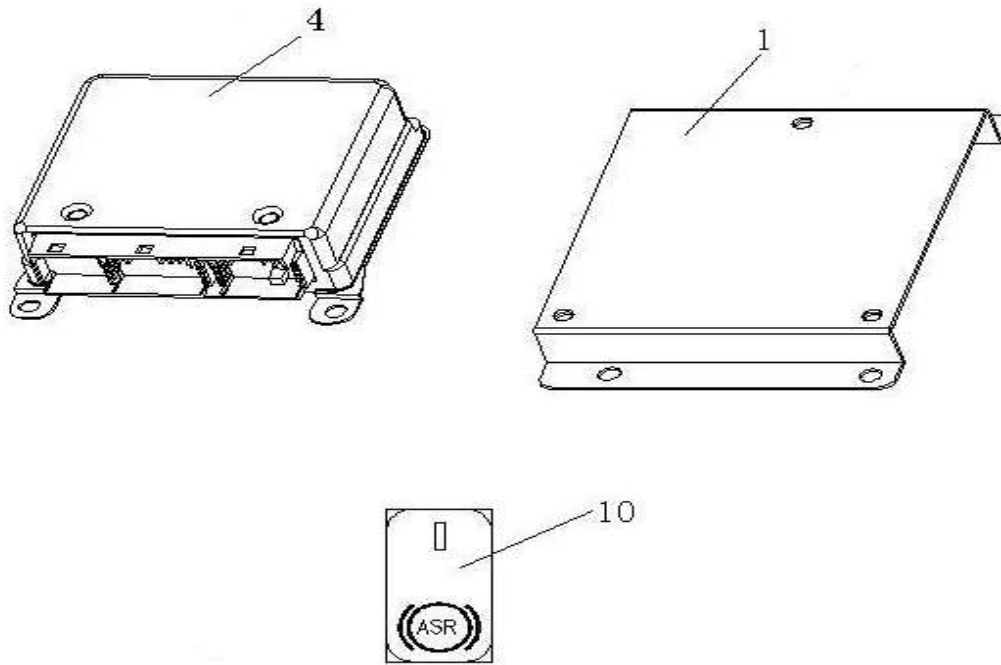

7.02 ABS (4S 4M) 控制装置/ABS ECU

序号 No.	零部件图号 Part No.	名称	Part Name	数量 Qty	备注 Remark
1	WG9725584027	ABS的ECU安装支架	Mounting plate	1	
3	Q2714216	十字槽盘头自攻螺钉	Screw	2	
4	WG9160580501	ABS (4S/4M) 电控单元 (WABCO)	ABS ECU	1	
6	Q2140616	十字槽盘头螺钉	Screw	3	
7	Q40106	平垫圈	Washer	3	
8	Q40306	弹簧垫圈	Spring washer	3	
9	Q340B06	I型六角螺母	Nut	3	
10	WG9719582014	ABS检测开关	Detection switch	1	
12	WG9719582034	ASR/ADR指示灯	Indicator	1	
14	Q2714216F31	十字槽盘头自攻螺钉	Screw	2	
15	Q2140616F31	十字槽盘头螺钉	Screw	3	

7.03 HOWO中央电气控制系统 (NanoBCU) /Central electric control system

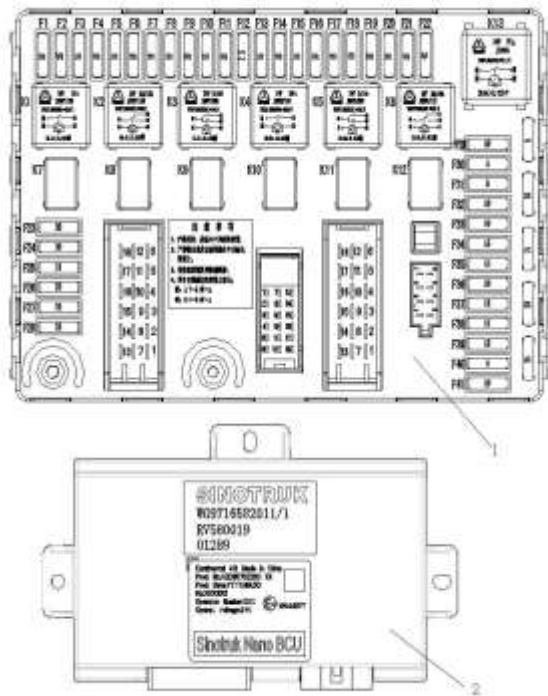

7.03 HOWO中央电气控制系统 (NanoBCU) /Central electric control system

序号	零部件图号	名称	Part Name	数量	备注
No.	Part No.			Qty	Remark
1	WG9716582301	电气接线盒总成	Caseassembly	1	
1,1	WG9716582301+	5A片式熔断器 (四川泛华)	Fuse-5A	4	
1,2	WG9716582301+	7.5A片式熔断器 (四川泛华)	Fuse-7.5A	1	
1,3	WG9716582301+	10A片式熔断器 (四川泛华)	Fuse-10A	16	
1,4	WG9716582301+	15A片式熔断器 (四川泛华)	Fuse-15A	15	
1,5	WG9716582301+	20A片式熔断器 (四川泛华)	Fuse-20A	4	
1,6	WG9716582301+	25A片式熔断器 (四川泛华)	Fuse-25A	5	
1,7	WG9716582301+	40A片式熔断器 (四川泛华)	Fuse-40A	1	
1,8	WG9716582301+	20A常开式继电器 (四川泛华)	Relay-20A	6	
1,9	WG9716582301+	40A常开式继电器 (四川泛华)	Relay-40A	2	
1,1	WG9716582301+	40A双联式继电器 (四川泛华)	Relay-40A	2	
1,11	WG9716582301+	70A常开式继电器 (四川泛华)	Relay-70A	1	
1,12	WG9716582301+	二极管 (四川泛华)	Diode	2	
1,13	WG9716582301+	40A转换式继电器 (四川泛华)	Relay-40A	2	

2	WG9716582011	NanoBCU控制器	BCU control unit	1	
3	Q2140612	十字槽盘头螺钉	Screw	4	
4	Q40306	弹簧垫圈	Springwasher	4	
5	Q40106	平垫圈	Washer	4	
6	Q2140510	十字槽盘头螺钉	Screw	1	
7	Q40305	弹簧垫圈	Springwasher	1	

7.03 HOWO中央电气控制系统 (NanoBCU) /Central electric control system

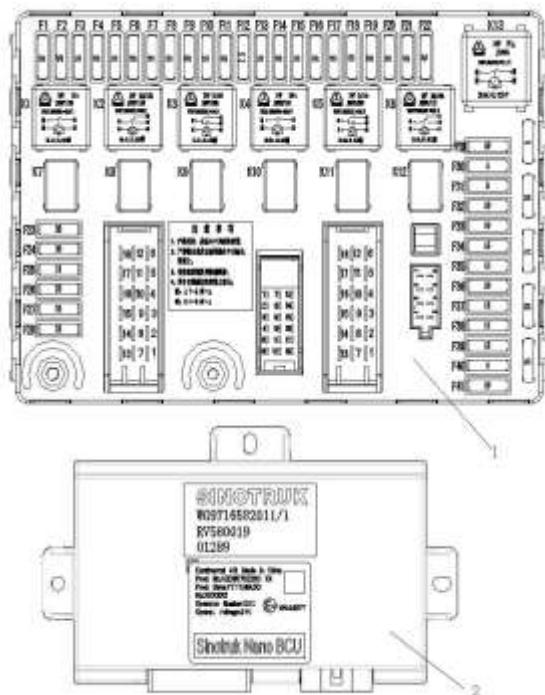

7.03 HOWO中央电气控制系统 (NanoBCU) /Central electric control system

序号	零部件图号	名称	Part Name	数量	备注
No.	Part No.			Qty	Remark
8	Q40105	平垫圈	Washer	1	
9	Q2140610	十字槽盘头螺钉	Screw	1	
10	Q40306	弹簧垫圈	Springwasher	1	
11	Q40106	平垫圈	Washer	1	
12	WG9716582102	HOWO电气接线盒左安装支	Bracket	1	
13	Q2140620	十字槽盘头螺钉	Screw	4	
14	Q40306	弹簧垫圈	Springwasher	4	
15	WG9716582104	控制器安装板	Install plate	1	
16	Q2140612	十字槽盘头螺钉	Screw	3	
17	Q340B06	I型六角螺母	Nut	3	
18	Q40206	大垫圈	Washer	3	
19	Q2714216F31	十字槽盘头自攻螺钉	Screw	2	

7.12 底盘电器/Chassis Electric Device

序号	零部件图号	名称	Part Name	数量	备注
No.	Part No.			Qty	Remark
1	WG9727710002	电子式气压传感器	Air pressure sensor	2	
2	WG9725710004	支架	Bracket	1	
3	WG9719710004	电磁阀(P99接头)	Solenoid valve	3	
4	WG9725584002	20A常开式继电器	20A relay (normally on)	1	
5	WG9725580006	100A保险装置	100A fuse	1	
6	WG9718710002	盆形电喇叭(莱州金声)	Electric horn	1	
7	Q2140620F31	十字槽盘头螺钉	Screw	2	
8	Q40306	弹簧垫圈	Spring washer	2	
9	Q1460825	组合件	Combination screw	1	
10	Q340B08	1型六角螺母	Nut	1	
11	WG9100710004	气压信号灯开关	Switch - air signal lamp	2	
12	Q150B08190	六角头螺栓	Screw	2	
13	Q40308	弹簧垫圈	Spring washer	2	
14	Q340B08	1型六角螺母	Nut	2	
15	Q2140410	十字槽盘头螺钉	Screw	1	
16	Q40304	弹簧垫圈	Spring washer	1	
17	Q40104	平垫圈	Washer	1	
18	Q150B0620	六角头螺栓	Screw	2	
19	Q40306	弹簧垫圈	Spring washer	2	
21	Q340B06	1型六角螺母	Nut	2	

7.13 HOWO车前照灯/Headlamp





7.13 HOWO车前照灯/Headlamp

序号	零部件图号	名称	Part Name	数量	备注
No.	Part No.			Qty	Remark
1	WG9719720002	右前照灯总成	Headlampass.-right	1	
2	WG9719720001	左前照灯总成	Headlampass.-left	1	
3	WG9719720025	前组合灯(左)	Frontlamp-left	1	
4	WG9719720026	前组合灯(右)	Frontlamp-right	1	
5	Q150B0830	六角头螺栓	Screw	4	
6	Q340B08	1型六角螺母	Nut	4	
7	Q40208	大垫圈	Washer	8	
8	Q40308	弹簧垫圈	Springwasher	4	
9	Q150B0820	六角头螺栓	Screw	2	
10	Q40308	弹簧垫圈	Springwasher	2	
11	Q40208	大垫圈	Washer	2	
12	Q150B0820	六角头螺栓	Screw	2	
13	Q40308	弹簧垫圈	Springwasher	2	
14	Q40208	大垫圈	Washer	2	
16	Q2714816F31	十字槽盘头自攻螺钉	Screw	4	
17	Q40205	大垫圈	Washer	4	
18	Q150B0825	六角头螺栓	Screw	6	
19	Q40208	大垫圈	Washer	12	
20	Q40308	弹簧垫圈	Springwasher	6	
21	Q340B08	1型六角螺母	Nut	2	

7.14 蓄电池 (165安-时) /165 AH Battery





16/19

20

车架

7.15 新型电瓶箱/Battery Box

序号 No.	零部件图号 Part No.	名称	Part Name	数量 Qty	备注 Remark
1	WG9725761005	HOWO电瓶箱体总成	BatteryBox	1	
2	Q151B1645	六角头螺栓	Screw	2	
3	Q151B1650	六角头螺栓	Screw	6	
4	190003888459	自锁螺母	Nut	8	
5	AZ9719770058	橡胶过孔护圈 (Φ50/Φ3)	Rubberring	2	
6	WG9100760100	电源总开关	Mainswitch	1	
7	199100760099	密封垫	Sealinggasket	1	
8	Q150B0835	六角头螺栓	Screw	2	
9	Q40308	弹簧垫圈	Springwasher	2	
10	Q40108	平垫圈	Washer	2	
11	AZ9100760102	电瓶箱盖	Batteryboxcover	1	
12	AZ9100760108	下橡胶垫板	Rubbercushion	1	
13	1682110021	橡胶缓冲块	Rubbercushion	6	
14	Q340B08	1型六角螺母	Nut	6	
15	Q40208	大垫圈	Washer	6	
16	Q40308	弹簧垫圈	Springwasher	6	
17	WG9100760104	压板	Plate	2	
18	Q150B0814	六角头螺栓	Screw	4	
19	Q33208	2型全金属六角锁紧螺母	Nut	4	
20	AZ9925760004	电器连接板	Plate	1	

7.15 新型电瓶箱/Battery Box

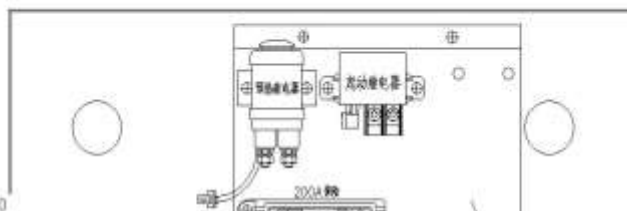
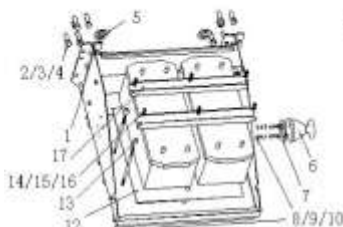

7.23 HW7E驾驶室电线束/Cab wiring harness

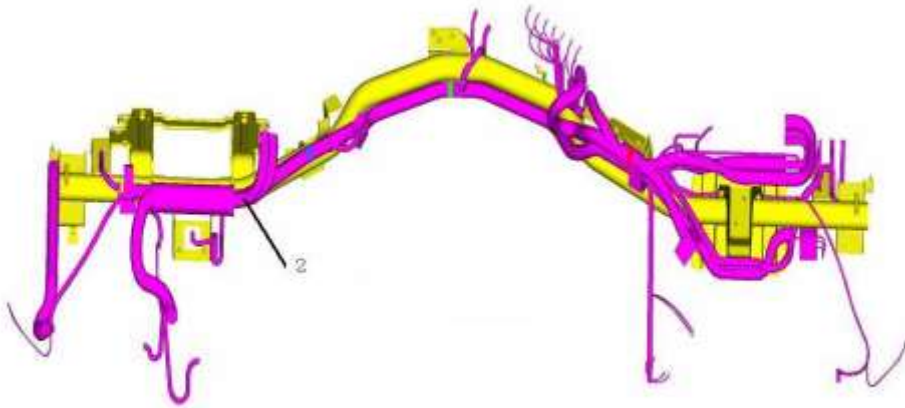

7.23 HW7E驾驶室电线束/Cab wiring harness

序号 No.	零部件图号 Part No.	名称	Part Name	数量 Qty	备注 Remark
2	AZ9721776011	HW7E驾驶室电线束	Cab wiring harness	1	
3	Q41205	外锯齿锁紧垫圈	Washer	3	
4	Q68620	单管夹片	Clip	1	
5	Q150B0616	六角头螺栓	Screw	1	
6	Q40306	弹簧垫圈	Spring washer	1	
7	Q340B06	I型六角螺母	Nut	1	
8	WG9725584005	120Ω电阻	120Ω Resistance	1	
9	WG9725580021	二极管总成 (3A)	Two-electrode valve assembl	2	
10	WG1642110018	保护条	Strip	10	
11	WG9725584031	过线盒体	Box	1	
12	Q150B0825	六角头螺栓	Screw	3	
13	Q340B08	I型六角螺母	Nut	3	
14	Q40108	平垫圈	Washer	6	

15	Q40308	弹簧垫圈	Spring washer	3	
16	WG9725584032	过线盒盖	Cover	1	
17	Q2140420	十字槽盘头螺钉	Screw	4	
18	AZ9719770047	橡胶过孔护圈 (Φ50)	Protect ring	1	
19	WG9100770392	分线盒体	Distributing box	1	
20	179100770391	配电箱	Distributing box	1	
21	Q2762995F31	开槽半沉头自攻螺钉	Screw	3	

7.23 HW7E驾驶室电线束/Cab wiring harness

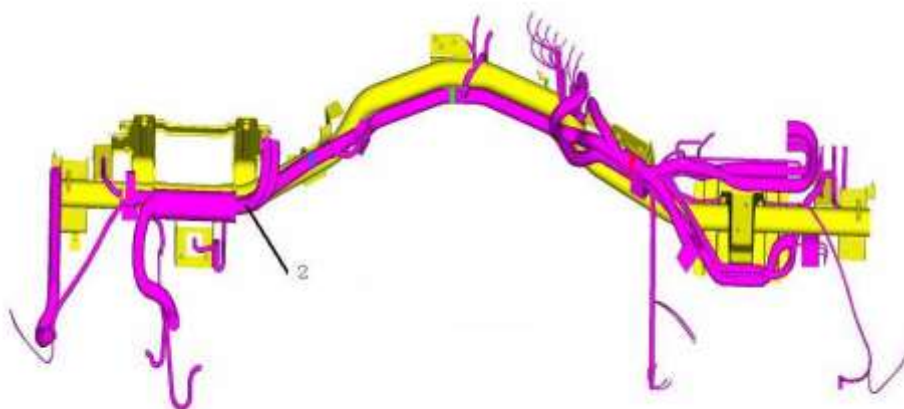

7.23 HW7E驾驶室电线束/Cab wiring harness

序号	零部件图号	名称	Part Name	数量	备注
No.	Part No.			Qty	Remark
22	WG9100770394	分线盒盖	Distributing box cover	1	
23	179100770395	电线护套	Protect sleeve	3	
24	179100770395	电线护套	Protect sleeve	1	
25	190003120032	园形密封条	Sealing strip	570mm	
26	Q2713525F31	十字槽盘头自攻螺钉	Screw	4	
27	Q150B0630Q	六角头螺栓	Screw	2	
28	Q40206	大垫圈	Washer	2	
29	Q40106	平垫圈	Washer	2	
30	Q40306	弹簧垫圈	Spring washer	2	
31	Q340B06	I型六角螺母	Nut	2	
32	WG9003171356	塑料紧固带A5*280	Fastener	15	

